

MEKANIKA

BOTTE D'ASPIRATION
CONTENU DU KIT 43 & 80MM

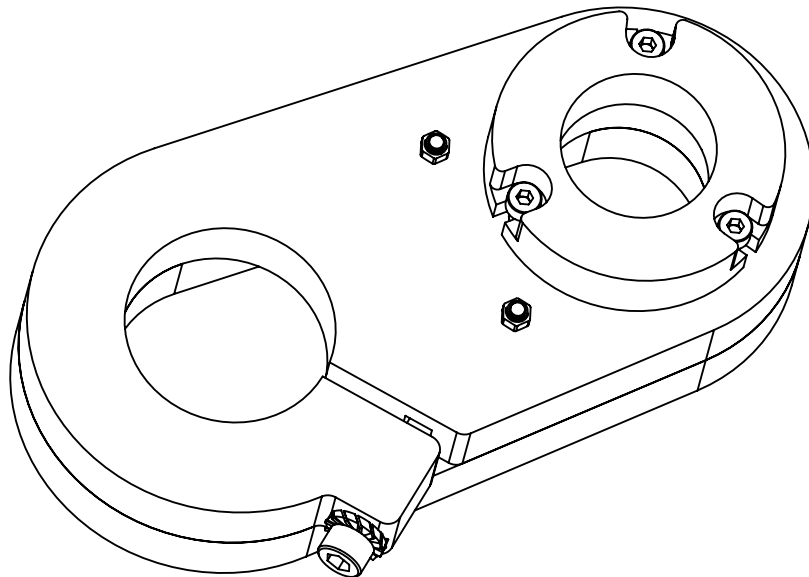









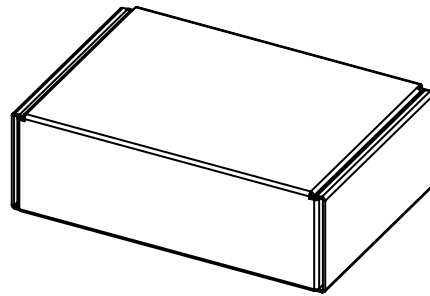





CONTENU DU KIT

BOTTE D'ASPIRATION

BOITE 1/1

↳ Tous les composants



ITEM	NOM	TYPE	43MM	80MM
	Pièces en PMMA (acrylique)	-		1
	Brosse	40mm		1
	Tuyau en aluminium	32mm		1
	Aimant	13mm / 20mm		2
	Rondelle pour aimant	12mm / 18mm		2
	Vis à tête fraisée	M3x12		2
	Vis DIN912	M3x10		2
	Vis DIN912	M4x20		3
	Vis DIN912	M6x40		1
	Rondelle crantée	M6		20
	Ecrou rectangulaire	M6		1
	Ecrou auto-freiné	M3		2
	Ecrou auto-freiné	M4		3